

APPROXIMATE WEIGHT: 43.8 LBS.



RV08-00 LOWER MOUNTING SYSTEM 170WB SPRINTER CUSTOMER SPEC SHEET

ROOST VANS, LLC
 PORTLAND, OREGON WWW.ROOSTVANS.COM 971.236.6684

THIS DOCUMENT CONTAINS CONFIDENTIAL AND PROPRIETY INFORMATION THAT CANNOT BE REPRODUCED OR DIVULGED, IN WHOLE OR IN PART WITHOUT AUTHORIZATION FROM ROOST VANS, INC.

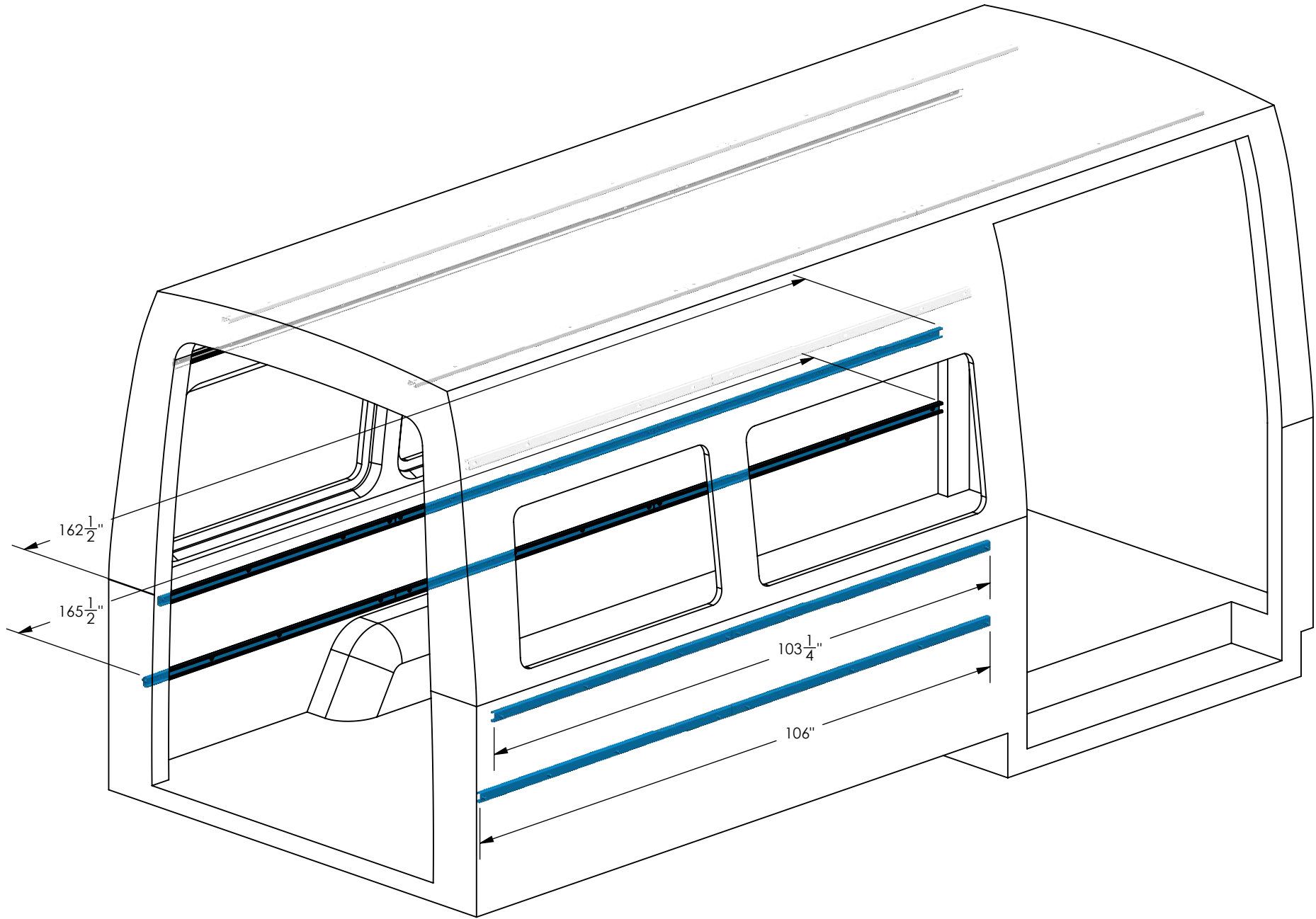

APPROXIMATE WEIGHT: 43.8 LBS.



RV08-00 LOWER MOUNTING SYSTEM 170WB SPRINTER CUSTOMER SPEC SHEET

ROOST VANS, LLC
 PORTLAND, OREGON WWW.ROOSTVANS.COM 971.236.6684

THIS DOCUMENT CONTAINS CONFIDENTIAL AND PROPRIETY INFORMATION THAT CANNOT BE REPRODUCED OR DIVULGED, IN WHOLE OR IN PART WITHOUT AUTHORIZATION FROM ROOST VANS, INC.

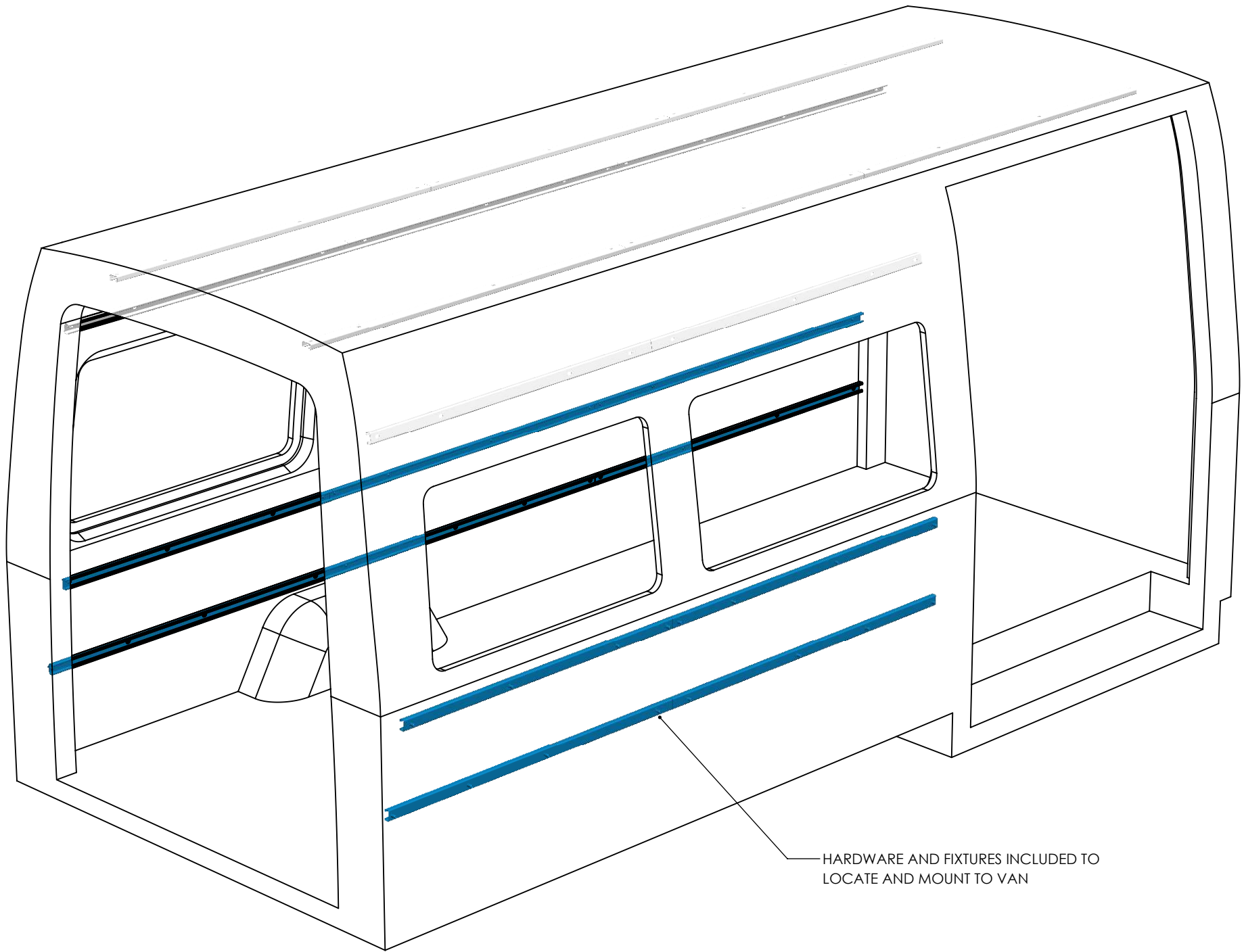

HARDWARE AND FIXTURES INCLUDED TO
LOCATE AND MOUNT TO VAN



RV08-00 LOWER MOUNTING SYSTEM 170WB SPRINTER CUSTOMER SPEC SHEET

ROOST VANS, LLC
PORTLAND, OREGON WWW.ROOSTVANS.COM 971.236.6684

THIS DOCUMENT CONTAINS CONFIDENTIAL AND PROPRIETY INFORMATION THAT CANNOT BE REPRODUCED OR DIVULGED, IN WHOLE OR IN PART WITHOUT AUTHORIZATION FROM ROOST VANS, INC.