

APPROXIMATE WEIGHT: 119.7 LBS.

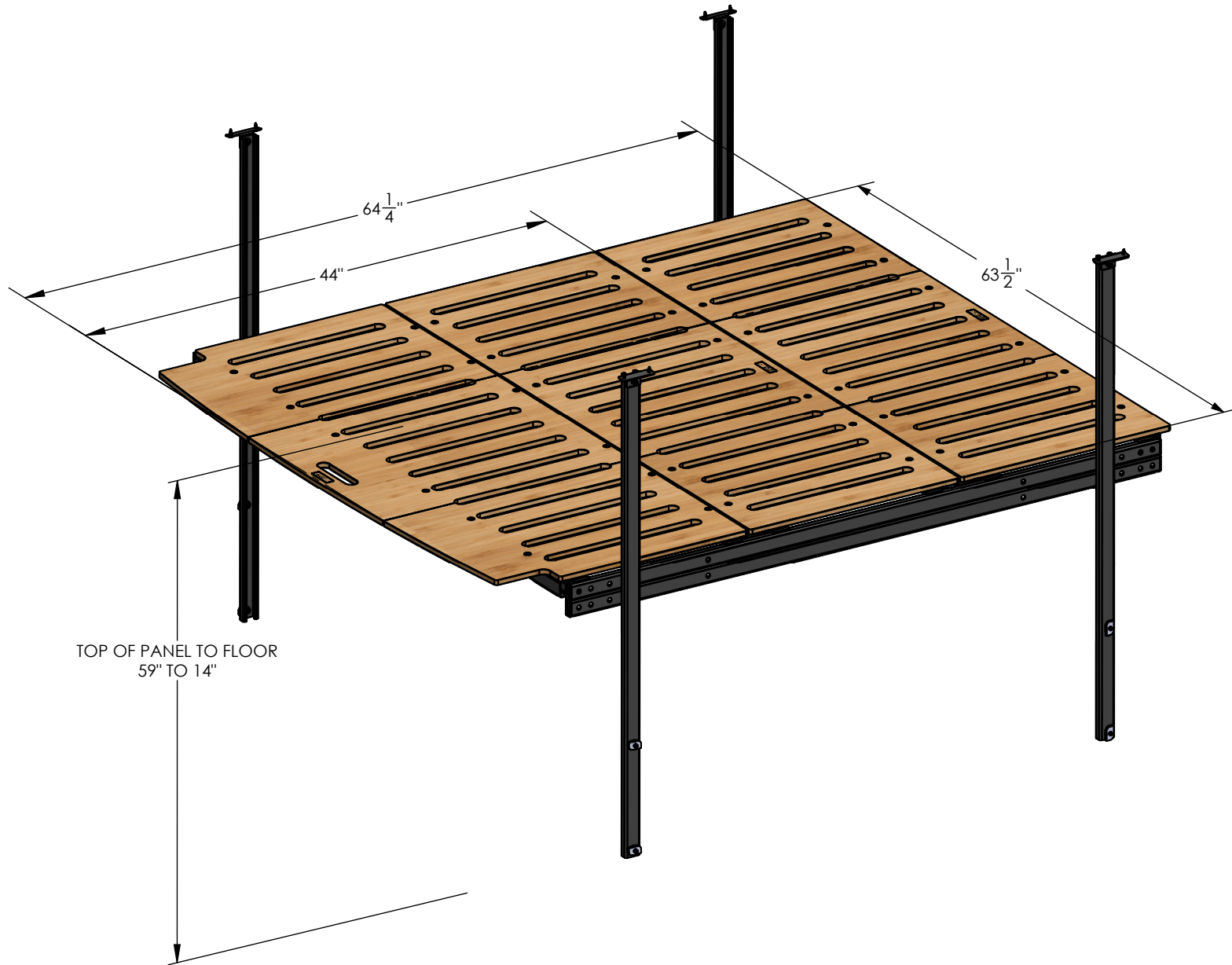

RV04 FU-KIT BED TRANSIT CUST SPEC SHEET

ROOST VANS, LLC
PORTLAND, OREGON
WWW.ROOSTVANS.COM



APPROXIMATE WEIGHT: 119.7 LBS.



RV04 FU-KIT BED TRANSIT CUST SPEC SHEET

ROOST VANS, LLC
PORTLAND, OREGON
WWW.ROOSTVANS.COM

INDIVIDUAL REMOVABLE PANELS

3 PLY FINISHED BAMBOO

HARDWARE INCLUDED TO MOUNT
TO ROOST MOUNTING SYSTEM

3 PANEL ~QUEEN BED SHOWN

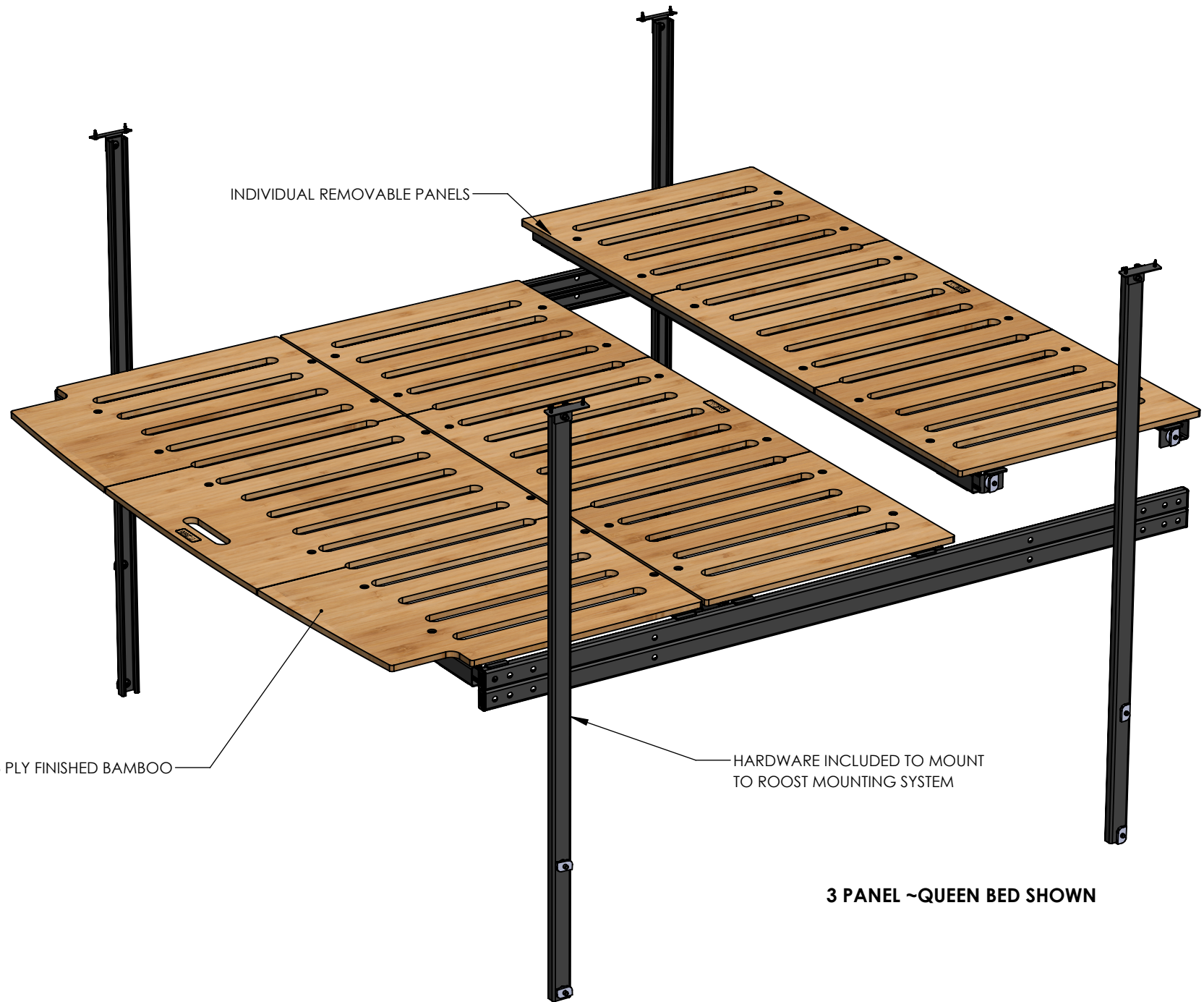

INDIVIDUAL REMOVABLE PANELS

3 PLY FINISHED BAMBOO

HARDWARE INCLUDED TO MOUNT
TO ROOST MOUNTING SYSTEM

3 PANEL ~QUEEN BED SHOWN

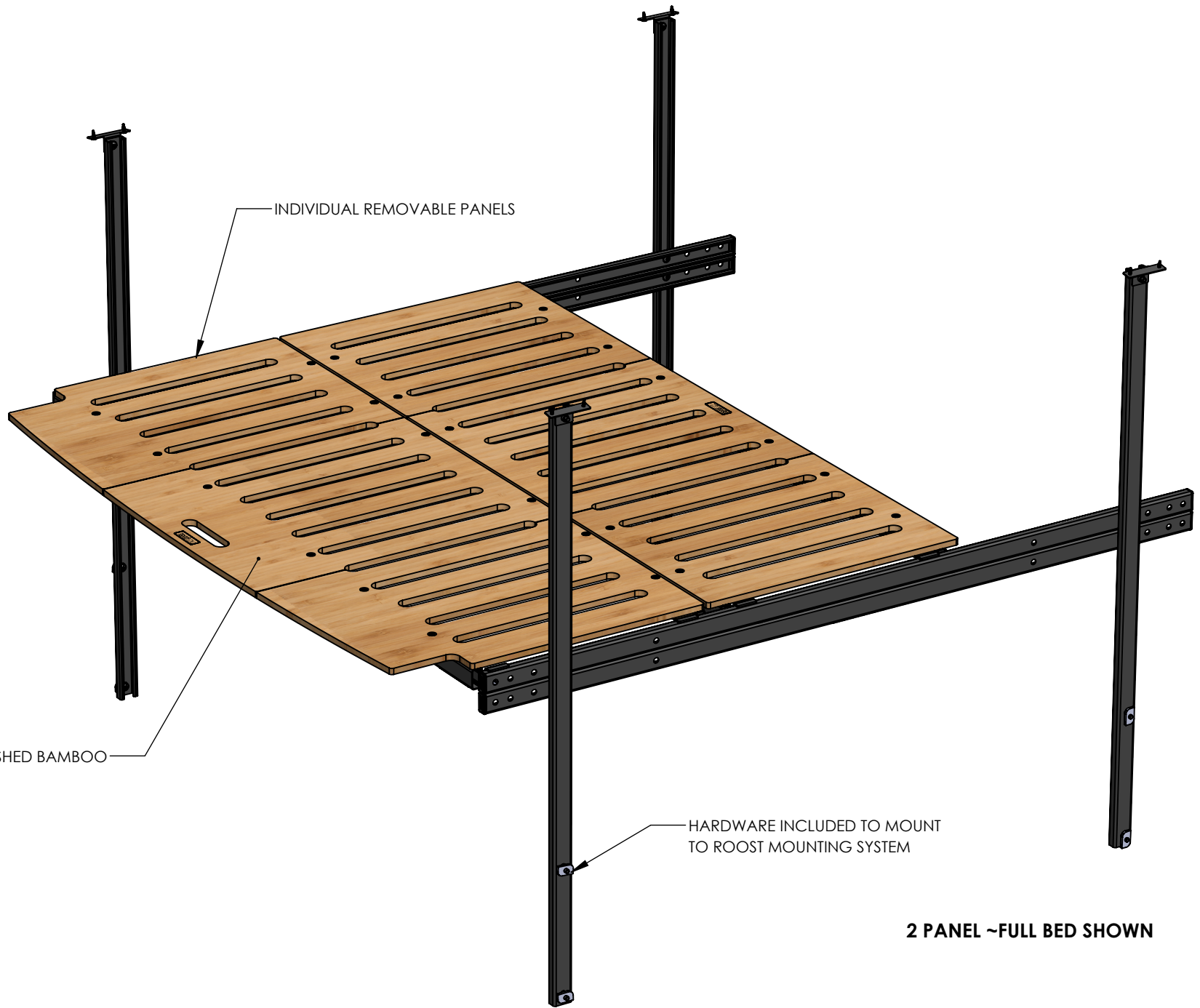

INDIVIDUAL REMOVABLE PANELS

3 PLY FINISHED BAMBOO

HARDWARE INCLUDED TO MOUNT
TO ROOST MOUNTING SYSTEM

2 PANEL ~FULL BED SHOWN

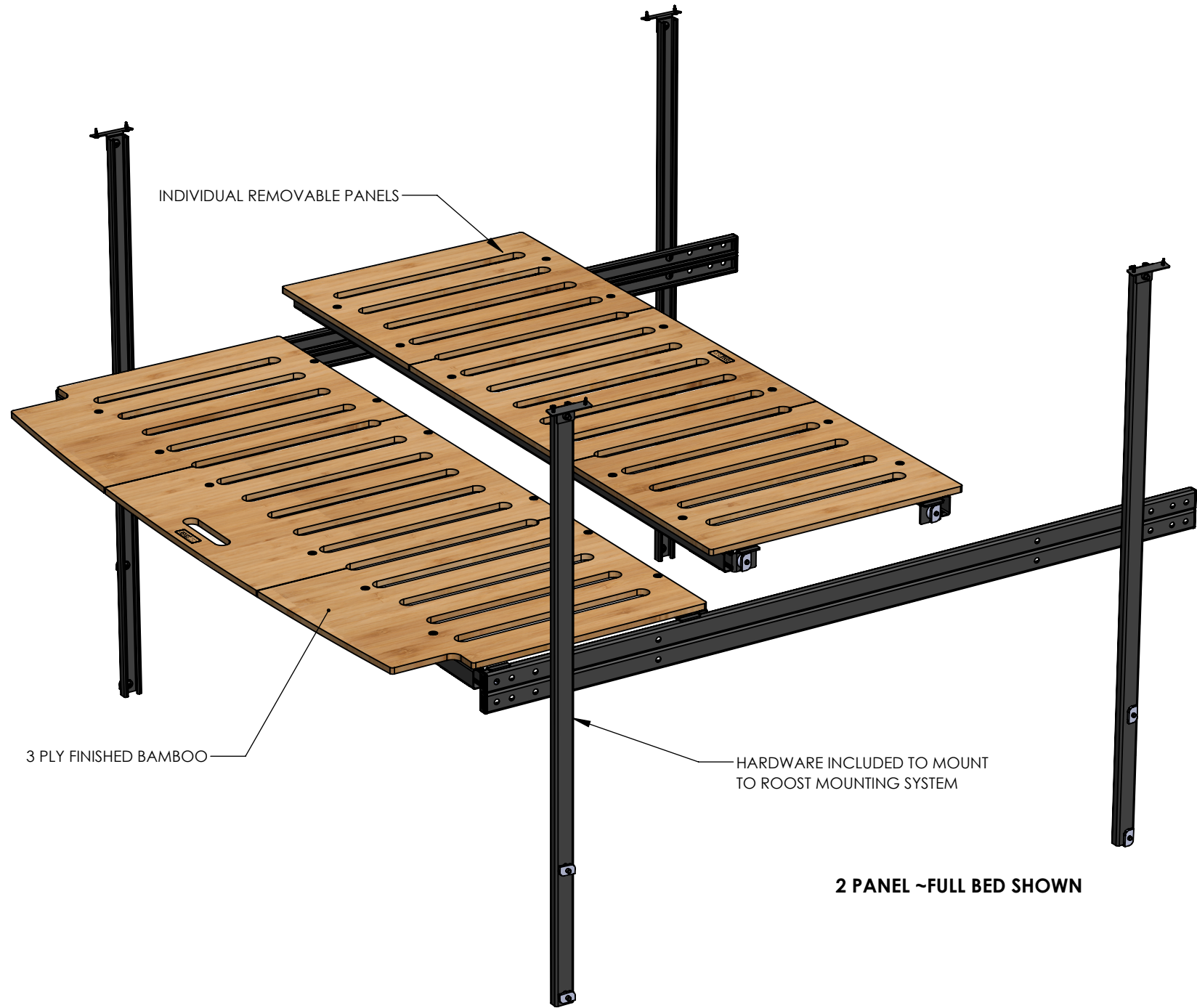

INDIVIDUAL REMOVABLE PANELS

3 PLY FINISHED BAMBOO

HARDWARE INCLUDED TO MOUNT TO ROOST MOUNTING SYSTEM

2 PANEL ~FULL BED SHOWN



FLIP-UP KIT INSTALLED ON REAR PANEL

HARDWARE INCLUDED TO MOUNT TO ROOST MOUNTING SYSTEM

3 PANEL ~QUEEN BED WITH 1 FLIP-UP KIT SHOWN



FLIP-UP KIT INSTALLED ON FRONT PANEL

HARDWARE INCLUDED TO MOUNT
TO ROOST MOUNTING SYSTEM

3 PANEL ~QUEEN BED WITH 1 FLIP-UP KIT SHOWN

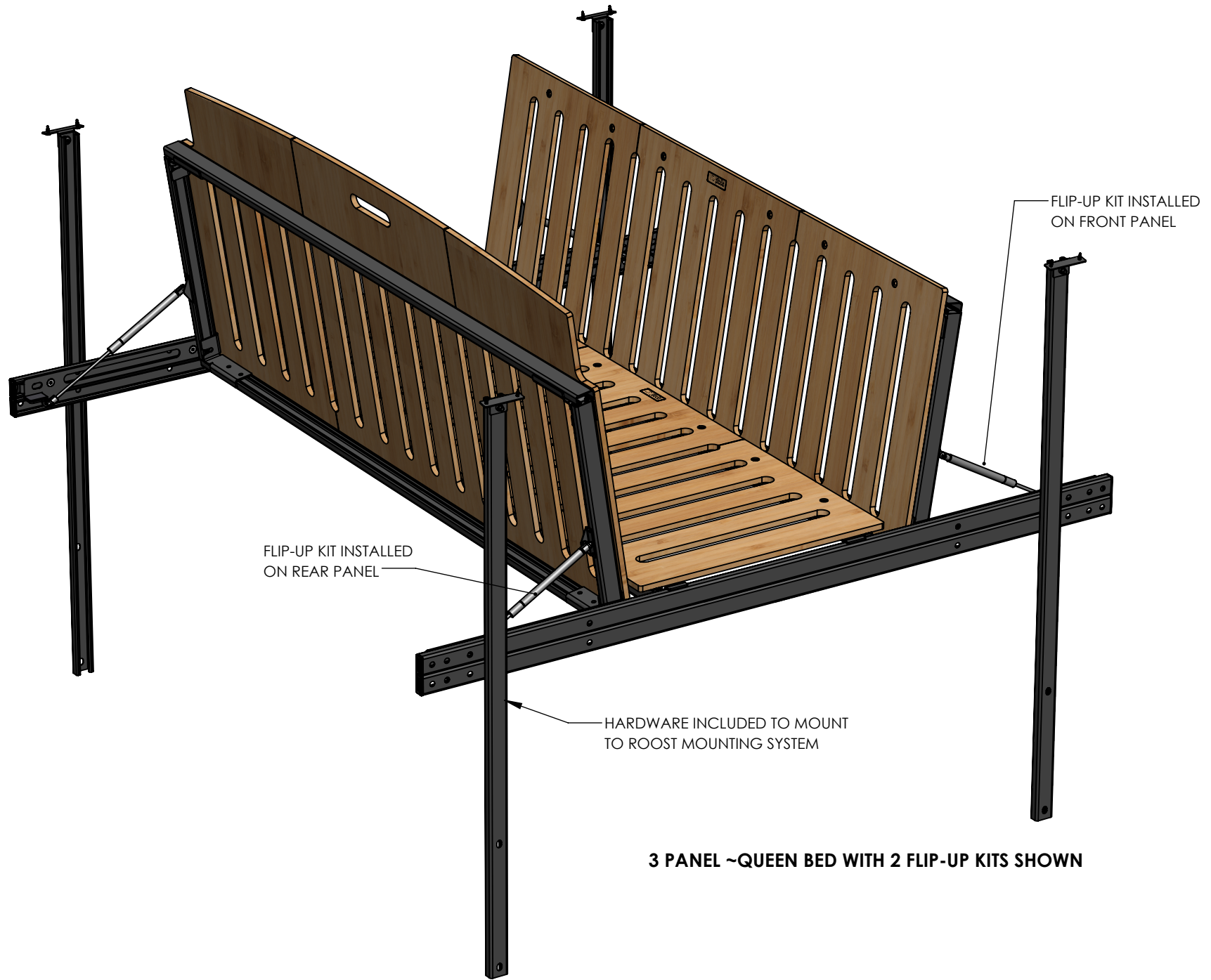

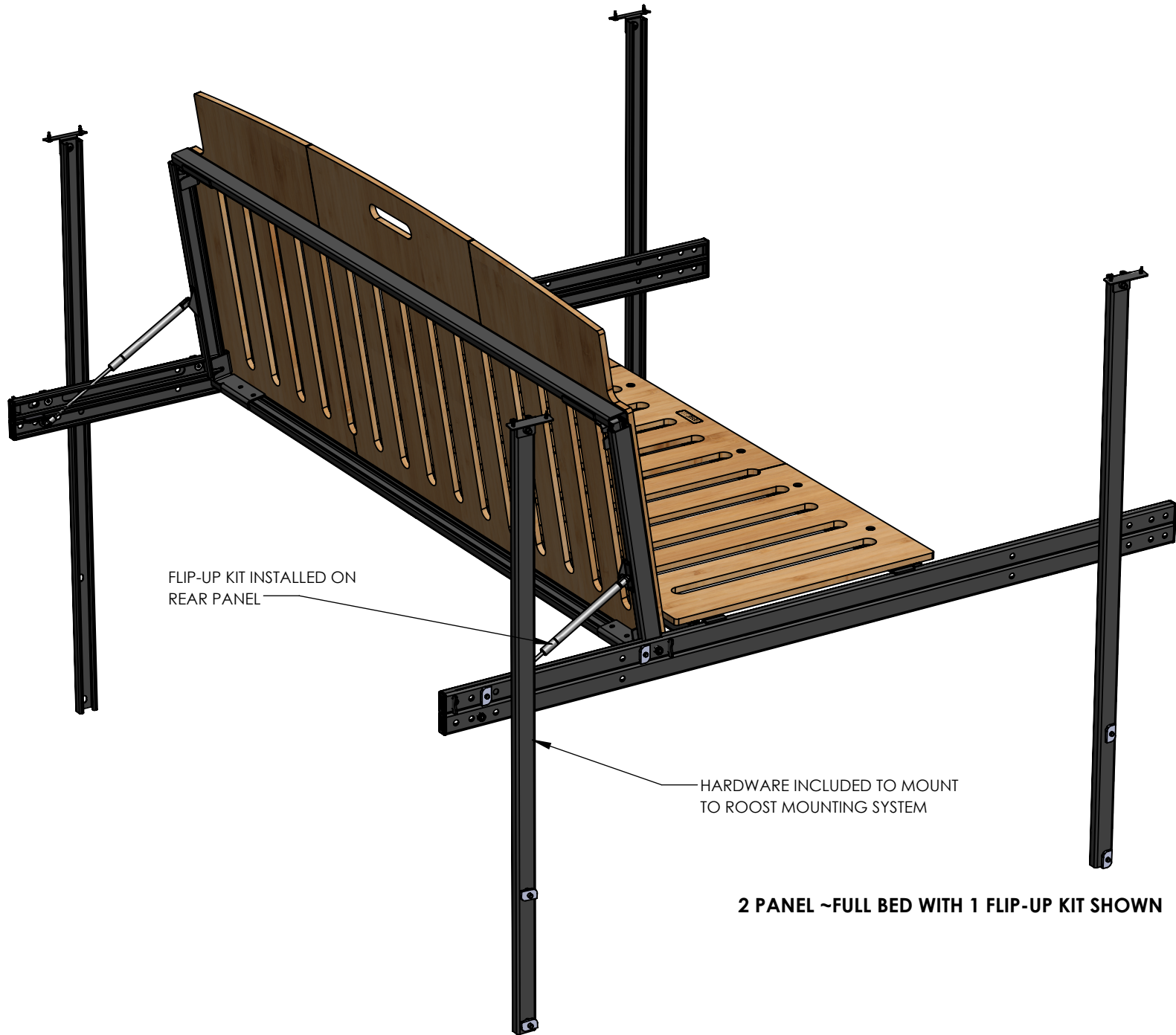

FLIP-UP KIT INSTALLED ON
REAR PANEL

HARDWARE INCLUDED TO MOUNT
TO ROOST MOUNTING SYSTEM

2 PANEL ~FULL BED WITH 1 FLIP-UP KIT SHOWN



FLIP-UP KIT INSTALLED ON FRONT PANEL

HARDWARE INCLUDED TO MOUNT TO ROOST MOUNTING SYSTEM

2 PANEL ~FULL BED WITH 1 FLIP-UP KIT SHOWN

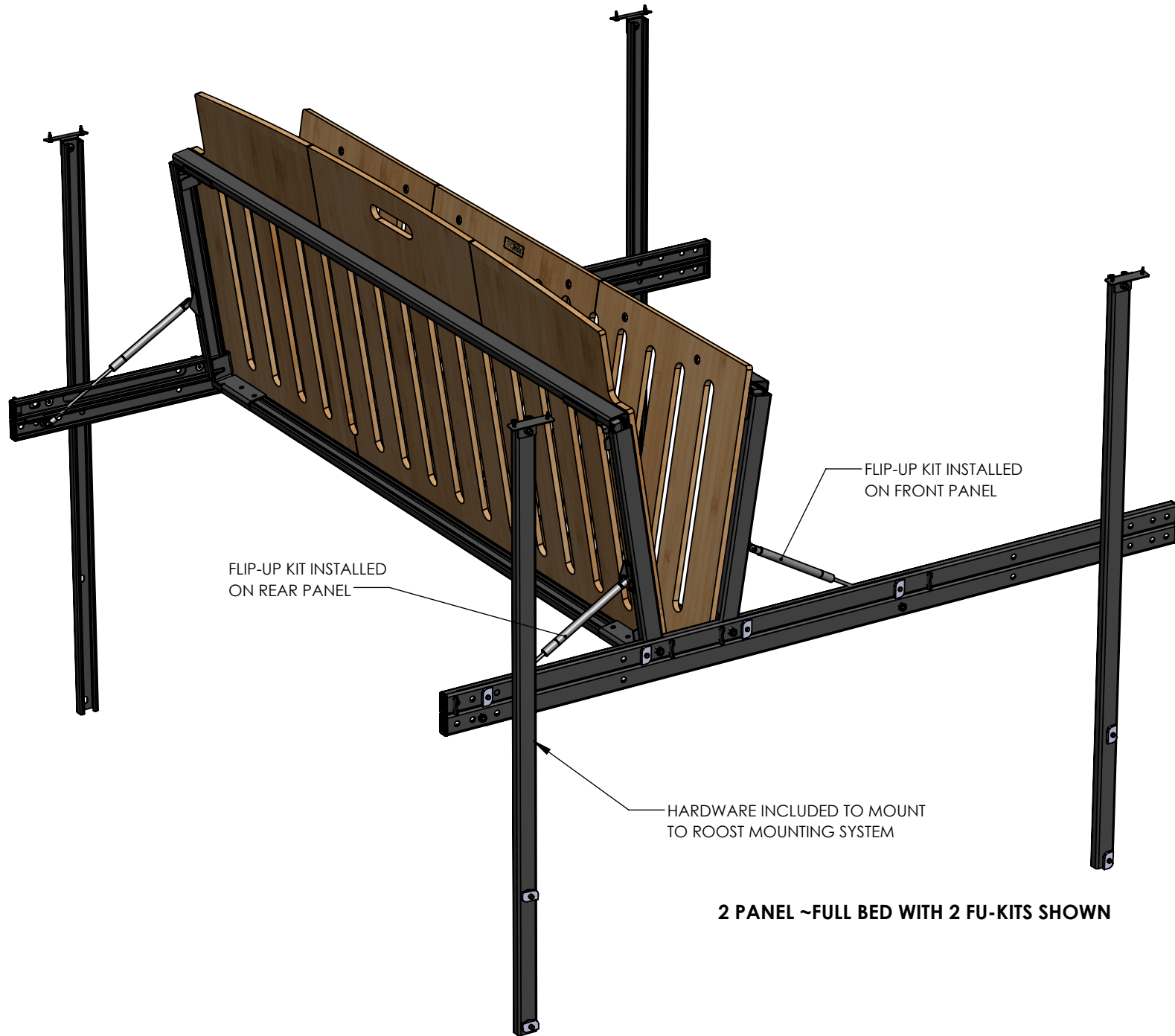

FLIP-UP KIT INSTALLED
ON REAR PANEL

FLIP-UP KIT INSTALLED
ON FRONT PANEL

HARDWARE INCLUDED TO MOUNT
TO ROOST MOUNTING SYSTEM

2 PANEL ~FULL BED WITH 2 FU-KITS SHOWN